

# **TRANSPORTA**

## Company Introduction

## Locations

- **Řehlovice** – HQ
- **Jičín** – Design office

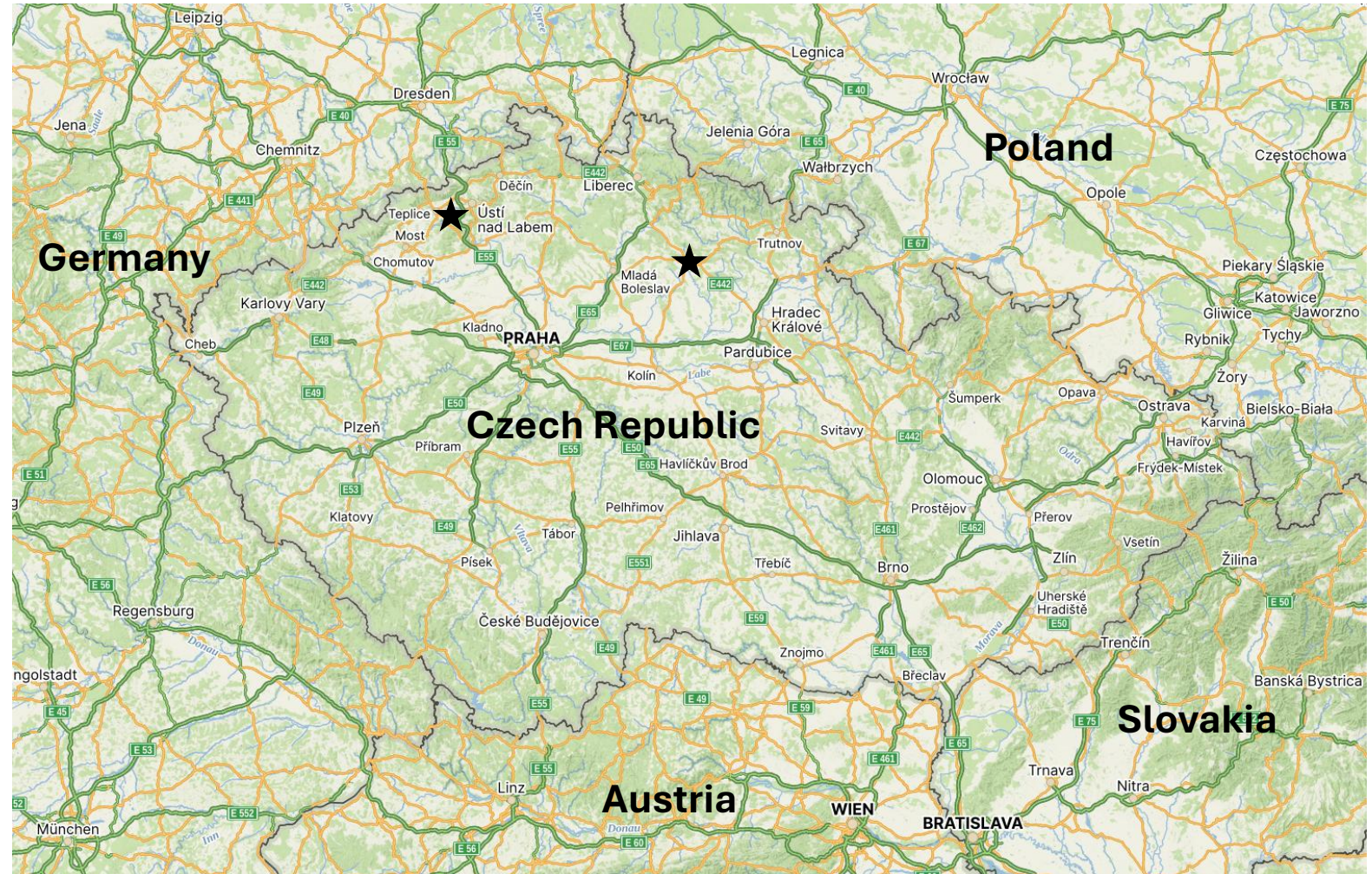

## Headquarter in Řehlovice



## Workshop in Řehlovice



- **Comprehensive services** throughout the entire life cycle of equipment or system
- **Focused industries:**
  - Power
  - Heating
  - Cement
  - Chemical
  - Paper
  - Steel
  - Mining

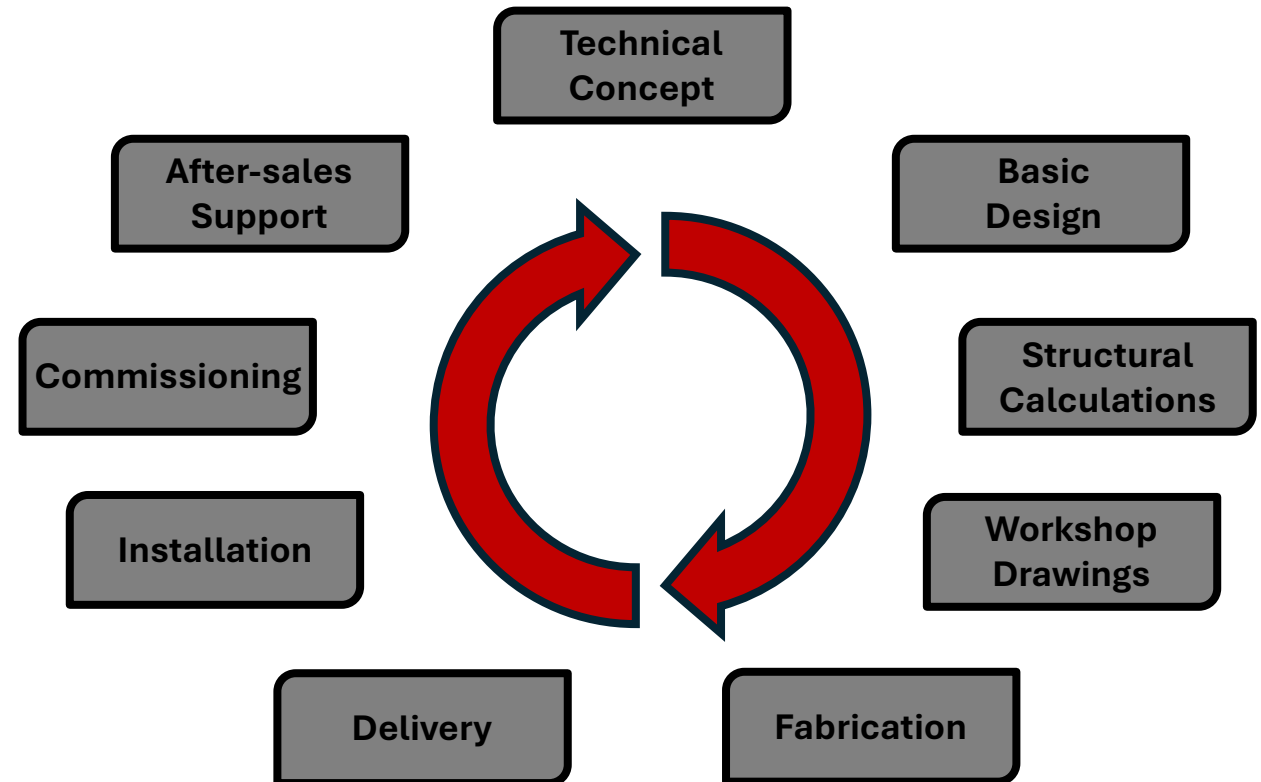

- Storage, conveying and feeding of fuels into kilns and boilers
- Removal of slag and ash from boilers
- Long-distance transport from quarries
- Storage of materials in landfills
- Unloading / loading of wagons and trucks
- Stackers / reclaimers
- Dedusting
- Inter-operation transport
- Storage halls, transfer towers



# Product Portfolio



- Pipe conveyors
- Chain conveyors (cooled as well)
- Chain-belt conveyors
- Screw conveyors (cooling as well)
- Belt conveyors
- Tripper cars
- Silos and buffer bins
- Moving floors
- Bucket elevators
- Fuel feeding devices

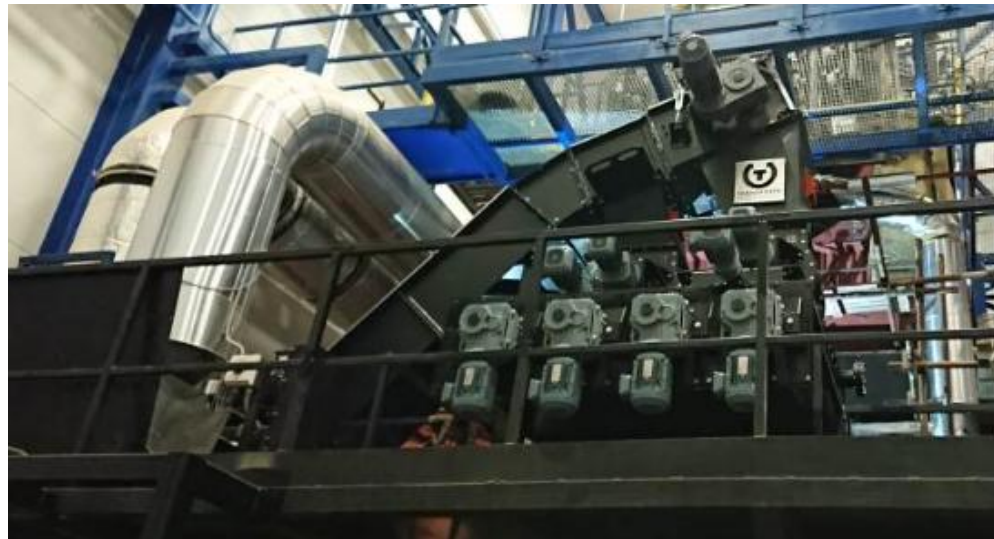

# Product Portfolio

- Reclaimers
- Shut-off gates
- Rod locks
- Expansion joints
- Disintegrators
- Star screens
- Disc screens
- Elliptic screens
- In-house pulleys for belt conveyors

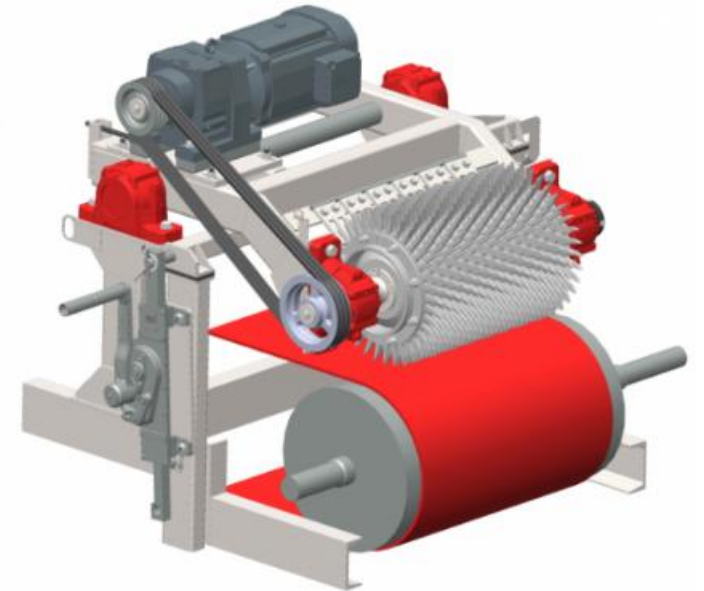

# Reference Selection



Transport of iron ore agglomerate

# Reference Selection



Wagon loading of gypsum

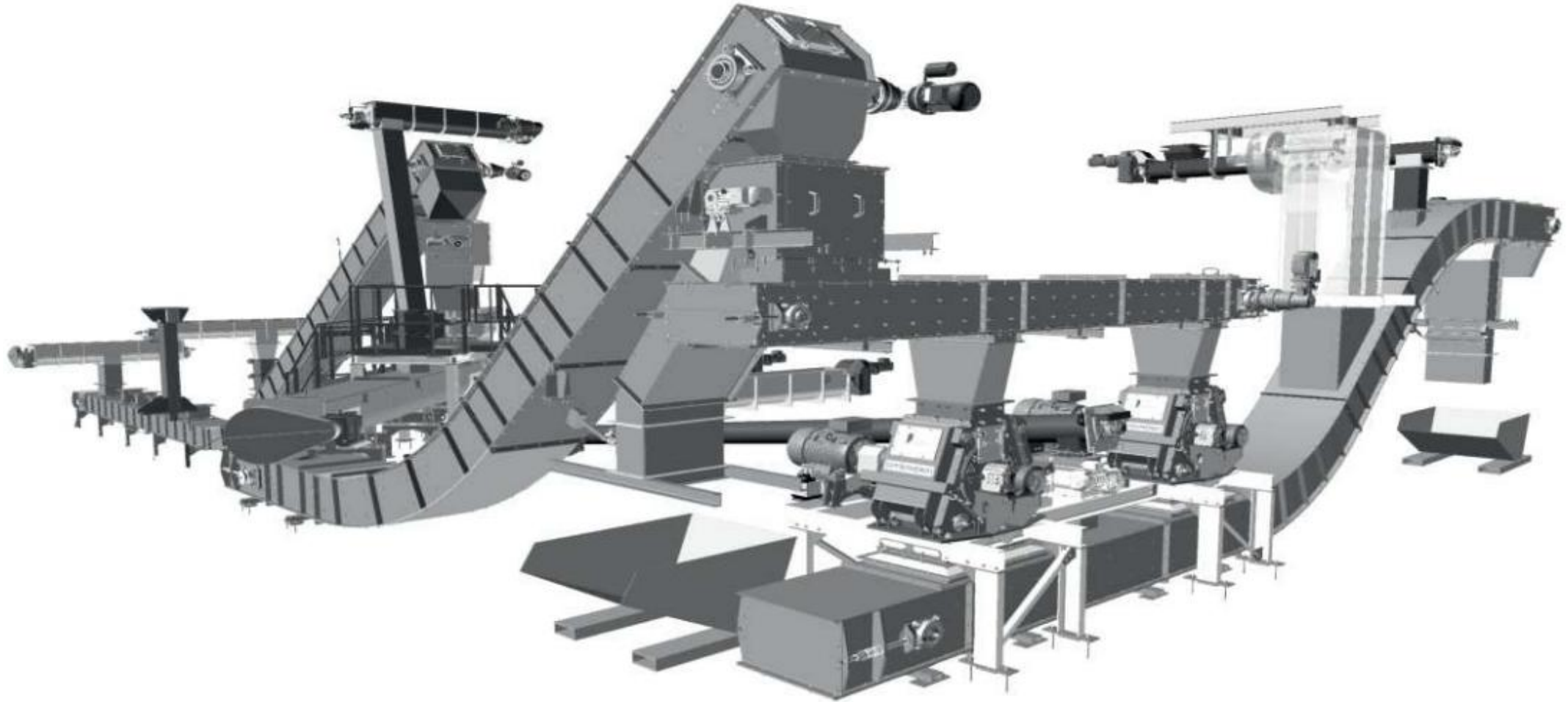

Transport of ash and slag from under the boiler

# Reference Selection

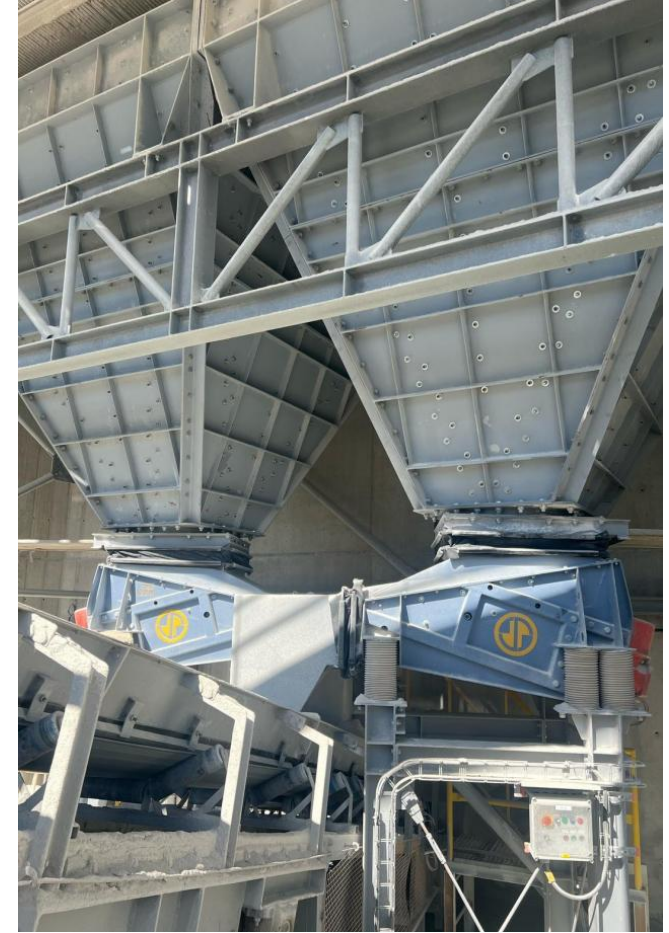

Wagon unloading station for limestone with downstream conveying

# Reference Selection



Transport of lime from the shaft kiln to the silo in front of the mill

# Reference Selection



Screening plant dedusting

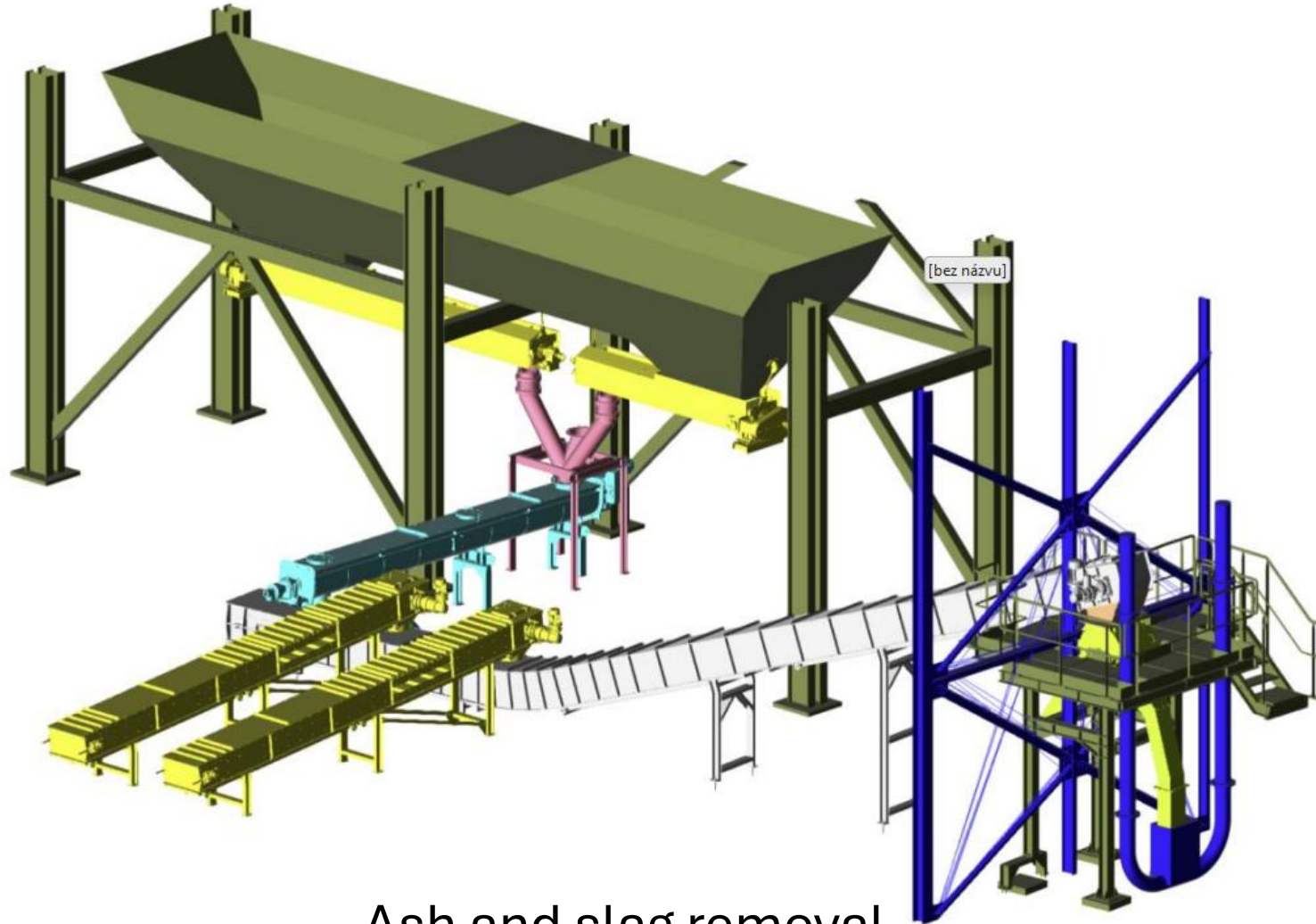

Ash and slag removal

# Reference Selection



Reclaimer for ammonium sulphate

# Reference Selection



Revamping of neutralization and decontamination station

- **Address:** Hliňany 18, 400 02 Řehlovice  
Czech Republic
- **Phone:** +420 475 351 314
- **E-mail:** [info@transporta.cz](mailto:info@transporta.cz)
- **Internet:** [www.transporta.cz](http://www.transporta.cz)

